

Laser gas-analysis study of CO₂, ethylene, and methane emissions by plants

B.G. Ageev, V.A. Kapitanov, Yu.N. Ponomarev, and V.A. Sapozhnikova

*Institute of Atmospheric Optics,
Siberian Branch of the Russian Academy of Sciences, Tomsk*

Received June 7, 2007

Results of synchronous measurements of biogenic gases emission by leaf apparatus of different plants are presented. The measurements have been carried out by gas-analysis methods in two spectral ranges: 1.6 and 10.6 μm . It is shown that CO₂ and ethylene concentrations in samples of the objects under study (conifer needles and rowan leaves) significantly exceed the background values; the methane emission was not registered.

Introduction

Gas exchange in plants is of special interest in the recent years in view of the problem of global climate change. Respiration of plants, particularly, dark one, along with photosynthesis are the primary components of the gas-exchange cycle; the CO₂ is the main emitted gas in this case, which simultaneously is the main greenhouse gas. New data appeared recently on methane emissions by different plants, which is the second after CO₂ important greenhouse gas.¹ Emitted amount of CH₄, estimated by the authors, gives grounds for revision the pattern of the methane concentration dynamics in the atmosphere, as well as of plant biochemistry.

Ethylene (C₂H₄) is a gasiform hormone of plants, synthesizing in them, regulating their growth and ripening, characterizing their response to different stress factors of both natural and anthropogenic character.

To study gas exchange in plants, the method of optical IR gas analysis is applied as one of the most rapid and exact methods in laboratory and field conditions.² Among laser gas analyzers, the most popular are devices using CO and CO₂ lasers, as well as diode lasers due to their capability to detect all basic components of the gas-exchange cycle in plants (CO₂, C₂H₄, NH₃, CH₄, H₂O).

Analyzers of trace atmospheric gases based on the diode and CO₂ lasers have been designed by now at the Laboratory of Absorption Atmospheric Spectroscopy IAO SB RAS.³ Their high concentration sensitivity is stipulated by the use of photo-acoustic detectors (PAD) and multipass matrix mirror systems. The analyzers allow computerized measurements both in free atmosphere and in closed volumes by means of filling the analytical cell with different gas samples or gas flowing through the cell and computer processing of the results.

This work presents the results of synchronous measurements of CO₂, C₂H₄, and CH₄ emissions by

leaf apparatus of conifers and foliage trees, carried out by gas analysis methods for the first time.

Experimental technique for studying gas exchange in plants

CO₂ laser gas analyzer

Measurements of carbon dioxide and ethylene emission by plants were carried out with a CO₂ laser gas analyzer (Fig. 1).

Principle of operation of the gas analyzer is based on the photo-acoustic (PA) effect resulting from the CO₂ laser radiation absorption by gases. A radiation source is a waveguide HF-excited CO₂ laser.⁴ Radiation wavelength is automatically tunable by means of a diffraction grating and motorized stepping-motor-driven screw. The laser radiates at seventy ¹²C¹⁶O₂ generation lines within the 9.2–10.8 μm range. The radiation passes through the PAD, which is a cylinder cell with a side-wall built-in capacitor microphone. The cell is exhausted and filled with gas with an exhaust unit. Gas molecules, having absorption lines at CO₂ laser wavelengths, absorb the modulated laser radiation, and acoustic vibrations at the modulation frequency are formed inside the PAD and registered by the microphone. The measured acoustic signal is proportional to the concentration of absorbing gas molecules in the gas sample. The radiation spectrum is computer-tunable via a specially-designed control unit. The value of the PA signal is recorded by the registration unit.

Laser methanometer

The used methanometer is the improved gas-analyzer that has been designed at GPI RAS on the base of a near IR Fabri–Perot diode laser (DL) and a multi-pass analytical cell⁵ (Fig. 2).

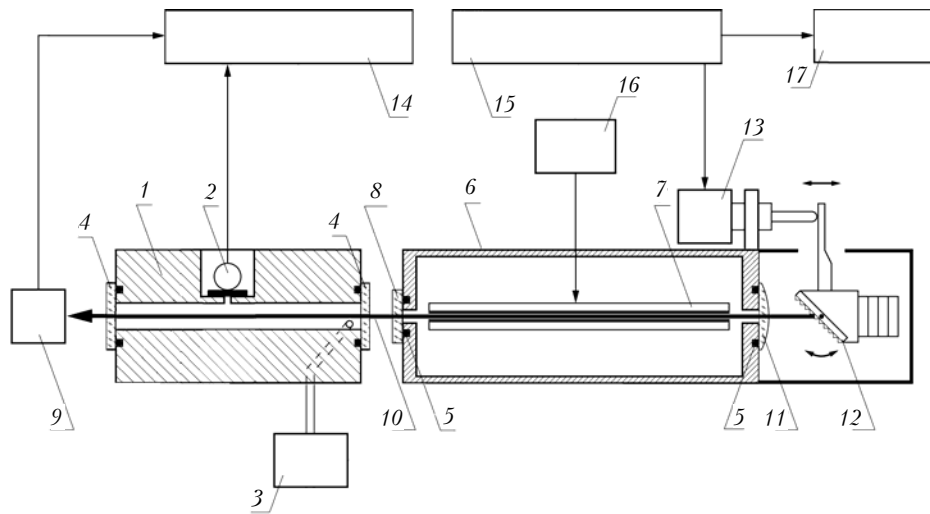

Fig. 1. Block-diagram of the laser photo-acoustic gas analyzer: PAD (1), microphone (2), exhaust unit (3), passage window (4), joint packing (5); body of the waveguide CO₂ laser emitter (6); waveguide (7); exit laser mirror (8); photodetector (9); output laser radiation (10); matching lens (11); radiation wavelength tuning unit with grating (12); stepping drive of the tuning unit (13); recording unit (14); control unit (15); HF laser pump (16); computer (17).

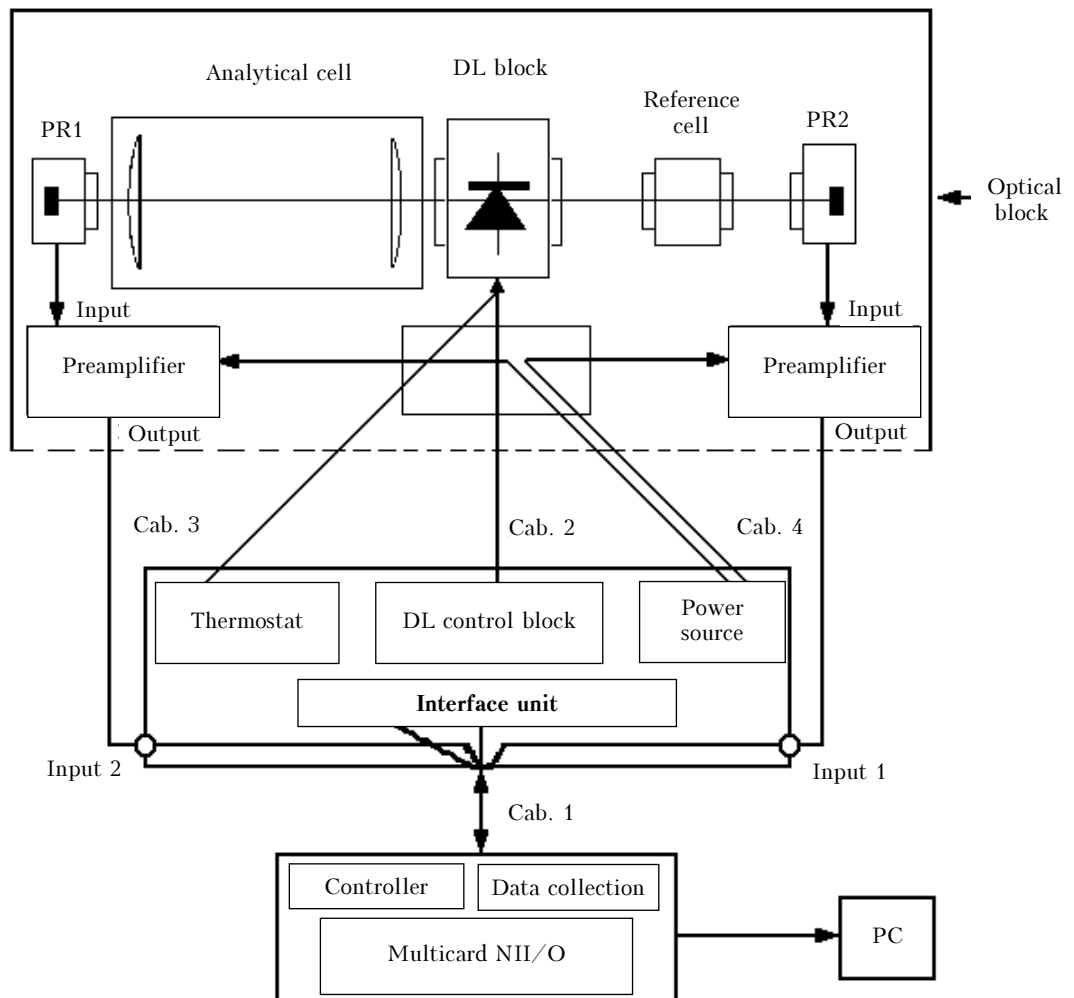

Fig. 2. Block-diagram of the laser methanometer.

The laser radiates in two opposite directions. Its main radiation comes into the multi-pass optical cell with a photoreceiver at its output. The air sample under study continuously circulates through the analytical cell. The oppositely directed laser radiation passes through the reference cell, filled with the mixture of methane with nitrogen of a definite concentration, to another photoreceiver. The technique for methane concentration measurement is based on calculation of the correlation function of signal shapes (absorption spectra of methane–nitrogen mixture and ambient air) in both channels.

Preparation of plant and gas samples

Gas emission by plants was studied in February – May, 2007 in the dark respiration mode using the leaf apparatus (leaves and needles) of trees (Siberian cedar, pine, and rowan). Trees were selected in the Akademgorodok forest near the Tomsk city. If the ambient temperature was negative, the selected branches were kept at the room temperature during 1 h. Samples (~100 g), detached from branches, were placed into the exposure cell of 0.003 m³ in volume. Leaf apparatus of trees is all-aged, which could manifest itself in different respiration activities. Therefore, samples were prepared with proportional shares of differing-age needles (leaves).⁶ To exclude photosynthesis, cells with samples were shaded. Air intake from the cells and its analysis were carried out after the 24-hour exposure.

The gas analyzers were CO₂ and CH₄ calibrated with high-purity (99.95%) control gas mixtures CO₂–N₂ and CH₄–N₂ (“PGS-Servis,” Zarechnyi, Sverdlovsk Region). The methanometer analytical cell and PAD cell volumes were blown in the beginning of measurements with the pure nitrogen (to define zero) and room air, then sampling from the exposure cells was performed, and again the cell volumes were blown with the pure nitrogen.

Gas samples were analyzed at the 10P10–10P22 lines (10.492–10.603 μm) of the CO₂ laser and in the 1.645–1.666 μm region of the diode laser.

Measurement results and discussion

The representative results for Siberian cedar needles are shown in Figs. 3 and 4.

Figure 3 exemplifies of the measured gas-sample absorption at the CO₂ lasing lines. A prerecorded air room absorption in the cell before placing samples in it is also shown. As is seen from comparison of the curves, dark respiration of needles in the experiment is accompanied not only by nitrogen but also ethylene emission, which has a characteristic absorption peak at the 10P(14) line (10.529 μm). The conducted PAD calibration allowed estimates of concentrations of studied gas sample components: ~1 ppm for C₂H₄ and 40 000 ppm for CO₂. Background atmospheric concentrations of these gases are 0.02 ppm and 350 ppm, respectively.⁷

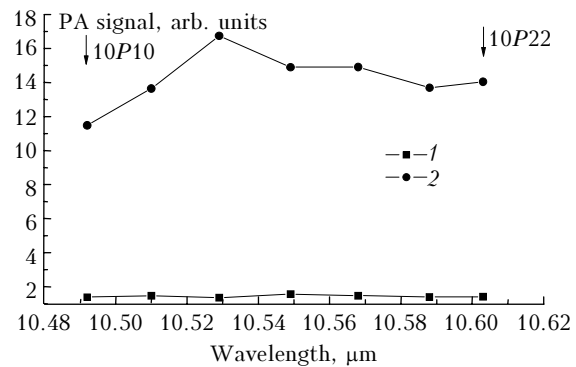

Fig. 3. Gas absorption within the CO₂ radiation range (*P*-branch of the 10 μm line): air room (1) and emission by Siberian cedar needles (2).

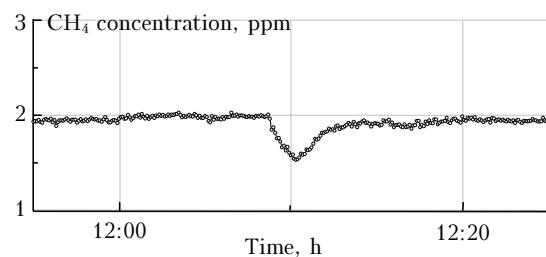

Fig. 4. Methane mixing ratio when blowing the methanometer cell with the air sample from the cell with Siberian cedar needles.

Figure 5 shows the same spectral region, computed by the LPM program,⁷ for air with CO₂ and C₂H₄ at the concentrations corresponding to the measured values.

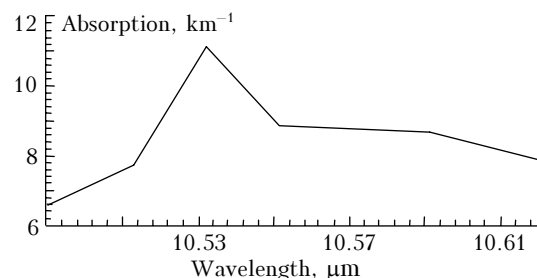

Fig. 5. Computed absorption spectrum of the air sample with CO₂ (~40 000 ppm) and C₂H₄ (~1 ppm) in the CO₂ laser radiation region.

The comparison of spectra gives a good qualitative agreement, which is confirmed by experimentally measured gas sample composition. When investigating the sample with the laser methanometer, a noticeable decrease of methane concentration in the mixture is determined, similarly to preliminary measurements⁸ (see Fig. 4). Data on ethylene absorption lines, falling into the tuning region of the used diode laser, are lacking in the literature, so, the assumption of qualitative character was made⁸ about the emitted ethylene effect. The conducted synchronous measurements confirm the assumption experimentally.

Similar measurements for the pine also revealed CO₂ and C₂H₄ in plant emissions, but in significantly less quantity, i.e., ~23 000 ppm and ~0.33 ppm,

respectively. Figures 6–8 show experimental and computed data.

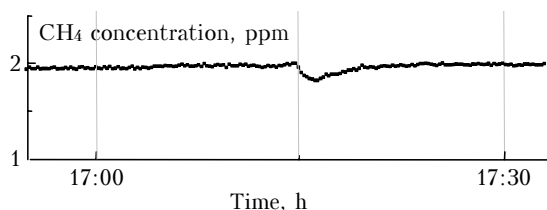

Fig. 6. Methane mixing ratio when blowing the methanometer cell with air from the cell with pine needles.

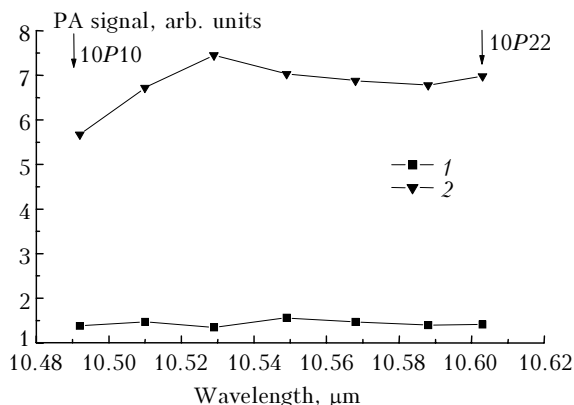

Fig. 7. Gas samples absorption in the CO_2 laser radiation region (P -branch of the $10\ \mu\text{m}$ line): room air (1) and pine needles emission (2).

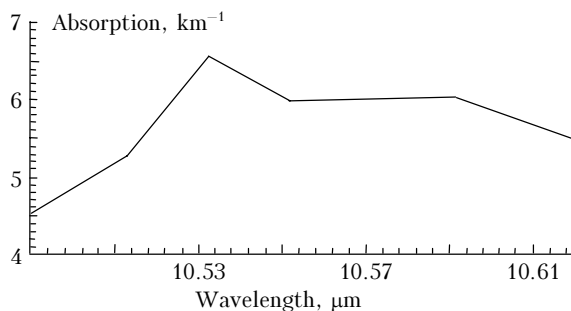

Fig. 8. Computed absorption spectrum of an air sample with CO_2 ($\sim 23\ 000$ ppm) and C_2H_4 (~ 0.3 ppm) in the CO_2 laser radiation region.

Dark respiration of juvenile rowan leaves was studied for comparison. The results have shown that the quantity of CO_2 and C_2H_4 in emitted gas samples is similar to pine ($\sim 22\ 000$ ppm and ~ 0.26 ppm, respectively); the methane emission was not registered as well.

Conclusion

The conducted synchronous measurements of dark respiration components of leaf apparatus of conifers and foliage trees have shown the presence of carbon dioxide and ethylene in amounts significantly exceeding the background values. Increased (relative to background) concentration of carbon dioxide in forests, especially under the tree crowns, is not seldom.⁹ As for ethylene, its emission by plants at the level of units of ppb was observed earlier under stresses (see, for example, Ref. 10).

In our case, more intensive ethylene emission occurred under standard airing conditions. This can be indicative of a variety of vital processes in different plants. Like in Ref. 8, we did not register methane emission by the studied plants, although the measurements were carried out in spring, when metabolism processes are most intensive. The results of Ref. 1 are probably species-specific characteristic of the studied plants. To check this, measurements with specially prepared plant samples or intercalibrating measurements by different techniques with the same samples of vegetation biota are required.

References

1. F. Keppler, J.T.G. Hamilton, M. Braz, and T. Rockman, *Nature (Gr. Brit.)* **439**, 187–191 (2006).
2. A.A. Nichiporovich, ed., *IR Gas Analyzers in Study of Gas Exchange in Plants* (Nauka, Moscow, 1990), 140 pp.
3. B.G. Ageev, V.A. Kapitanov, Yu.N. Ponomarev, V.A. Vasilyev, A.I. Karapuzikov, and I.V. Sherstov, *Proc. SPIE* **6522**, 65221Q (2006).
4. I.V. Sherstov, K.V. Bychkov, V.A. Vasilyev, A.I. Karapuzikov, V.V. Spitsyn, and S.B. Chernikov, *Atmos. Oceanic Opt.* **18**, No. 3, 248–253 (2005).
5. *Methanometer*. GPI RAS. Technical specification.
6. I.V. Katrushenko and K.F. Starostin, in: *Proc. of Komi Workshop "Gas Exchange in Plants in Crops and Natural Phytocenoses"* (Syktyvkar, UB RAS, 1992), p. 29.
7. V.V. Zuev, A.A. Mitsel', M.Yu. Kataev, I.V. Ptashnik, and K.M. Firsov, *Computers in Phys.* **9**, No. 6, 649–656 (1995).
8. V.A. Kapitanov and Yu.N. Ponomarev, *Atmos. Oceanic Opt.* **19**, No. 5, 354–358 (2006).
9. A.S. Shcherbatuk, L.V. Rusakova, G.G. Suvorova, and L.S. Yan'kova, *CO₂ Gas Exchange Between Conifers in the Cis-Baikal Region* (Nauka, Novosibirsk, 1991), 135 pp.
10. F.J.M. Harren, F.G.G. Bijnen, J. Reuss, L.A.C.J. Voeselek, and C.W.P.M. Blom, *Appl. Phys. B* **50**, No. 2, 137–144 (1990).